

MODEL NO	PASLANMAZ (STAINLESS)	SİYAH (BLACK)	F1 (N)	F2 (N)	F3 (N)	F4 (N)	Fi		BASKI VİDASI (SQUEEZE SCREW)	AÇI (ANGLE) (± 5 °)	AĞIRLIK (WEIGHT) (gr)
							(X1) VERİM (YIELD) (F1 : Fi)	(X2) VERİM (YIELD) (F2 : Fi)			
111 - 0	S 111 -	B 111 -	450	300	520	350	5:1	2:1	M4X25	90 °	42
111 - 1	S 111 -	B 111 -	850	650	1000	800	7:1	3:1	M5X35	90 °	125
111 - 2	S 111 -	B 111 -	1000	750	1200	1000	7:1	3:1	M6X40	90 °	225
111 - 3	S 111 -	B 111 -	2300	1250	2500	1350	8:1	4:1	M8X50	90 °	340
111 - 4	S 111 -	B 111 -	3500	1800	3650	2000	9:1	4:1	M10X70	90 °	810
111 - 5	S 111 -	B 111 -	4500	2000	5000	2125	10:1	5:1	M12X80	90 °	1520

F1 - F2 : BASKI KUVVETİ (EXERTING FORCE), F3 - F4 : TUTMA KAPASİTESİ (HOLDING CAPACITY), Fi : UYGULAMA KUVVETİ (APPLIED FORCE)

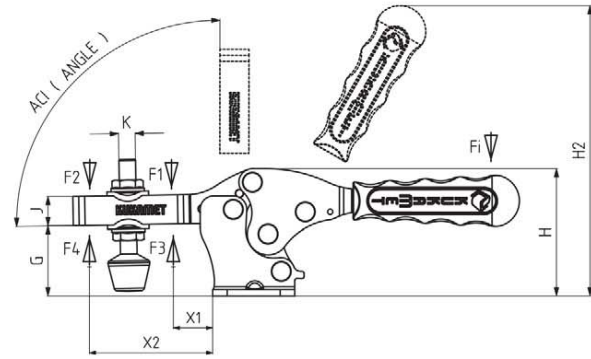

Ayak Tipi: Çatay Tabanlı
Body Mounting Base: Horizontal

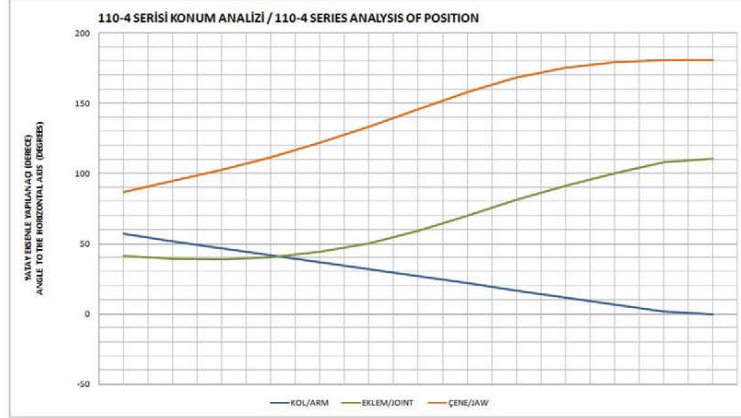

MODEL NO : 111-0 (KAPLAMASIZ METAL SAP)

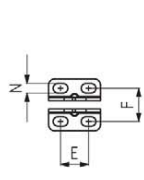
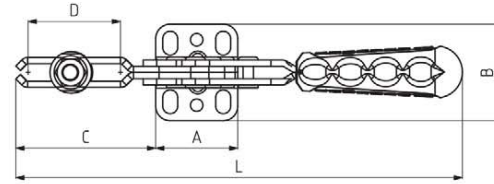

MODEL NO : 111-0

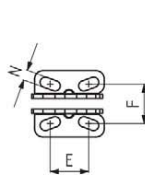

MODEL NO : 111-1

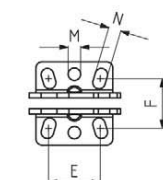

MODEL NO : 111-2

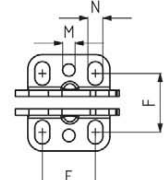

MODEL NO : 111-3

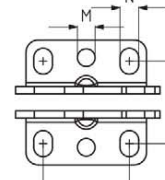

MODEL NO : 111-4

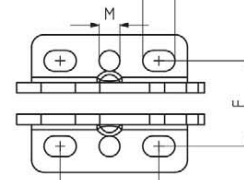

MODEL NO : 111-5

MODEL NO	A	B	C	D	E	F	G	H	H2	J	K	L	M	N	X1	X2
111 - 0	25	25	25,5	13	11 - 16	16	15	24	60	7,5	M4	82,5		4,5 x 7	11	18
111 - 1	33,5	32	43	28	14 - 23	17,5 - 20,5	21	40	95	10	M5	148		5 x 10	15	33
111 - 2	37	40	66	47	23,7 - 26	20 - 27,5	28	51	110	14	M6	184	Ø 6	6 x 10	19	54
111 - 3	39,5	46,5	68	42	25,5	24 - 32,5	34	61	136	14	M8	215	Ø 6	7 x 11,5	25	53
111 - 4	58	60	100	73	41,5	36 - 43	45	82	175	19	M10	296	Ø 8,5	9 x 12,5	27	83
111 - 5	75	66	129	92	42 - 53	42	55	104	218	25,5	M12	345	Ø 10	10 x 15,5	37	107